

## ALKALINE-MANGANESE DIOXIDE BATTERY

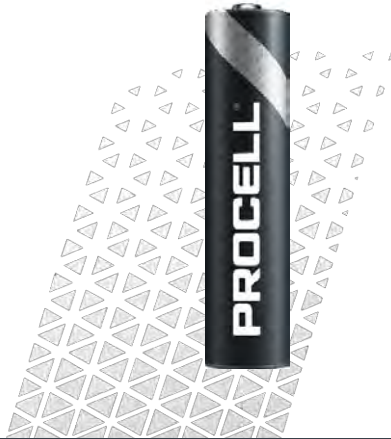

Size: AAA (L03) PC2400

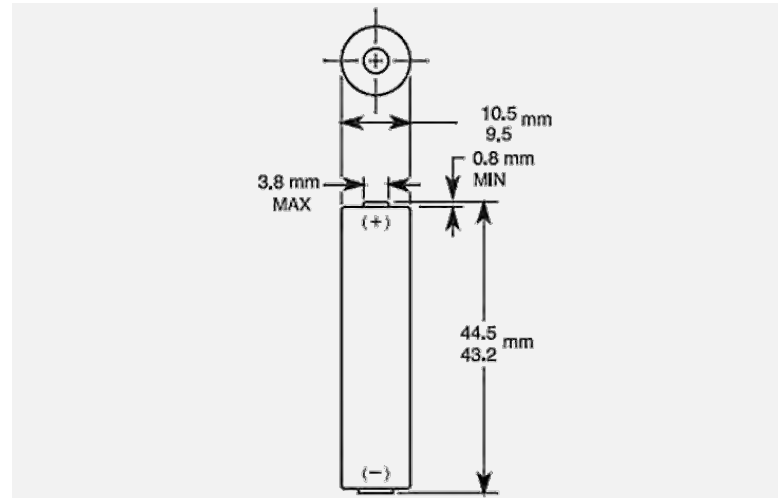

Dimensions shown are IEC standards

### KEY FEATURES

- Reliable Performance
- Excellent resistance to corrosion
- Designed to meet all major quality, safety and environmental standards:
  - Safety: IEC 60086-5
  - ANSI C 18.1M, Part-2
  - EU Battery Directive
  - Quality: ISO 14001 and 9001, Duracell World Class Continuous Improvement Program

### TYPICAL APPLICATIONS

- Remote Controls
- Sensors
- Security keypads
- Wireless mouse

### ELECTRICAL CHARACTERISTICS

- |  |           |
|--|-----------|
| ▪ Nominal capacity (43 Ω Cont., .8V cut-off) | 1,236 mAh |
| ▪ Typical Voltage (at + 20 °C)               | 1.5 V     |
| ▪ AC Impedance @ 1kHz                        | 116 mΩ    |

### PHYSICAL CHARACTERISTICS

- |                  |  |
|------------------|--|
| ▪ Typical weight | 11.6 g (0.4 oz)                            |
| ▪ Typical volume | 3.5 cm <sup>3</sup> (0.2 in <sup>3</sup> ) |
| ▪ Terminals      | Flat                                       |

### OPERATING & STORAGE CONDITIONS

- |  |                                  |
|--|----------------------------------|
| ▪ Operating temperature range  | -20°C to 54°C<br>(-4°F to 130°F) |
| ▪ Recommended Storage (storage area should be clean, cool, dry and ventilated) | 5°C to 30°C<br>(41°F to 86°F)    |

**PROCELL**<sup>®</sup>

PROFESSIONAL BATTERIES

Procell Professional batteries

Berkshire Corporate Park

Phone: 1-800-544-5454 (Toll-free)

[www.procell.com](http://www.procell.com)

Delivered capacity is dependent on the applied load, operating temperature and cut-off voltage. Please refer to the charts and discharge data shown for examples of the energy/service life that the battery will provide for various load conditions.

This data is subject to change. Performance information is typical. Contact Duracell for the latest information.

TYPICAL PERFORMANCE

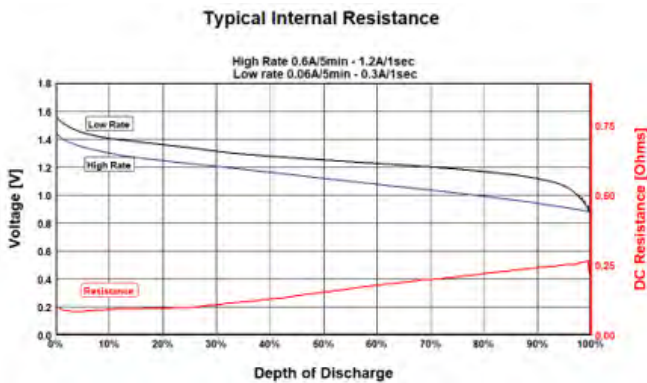
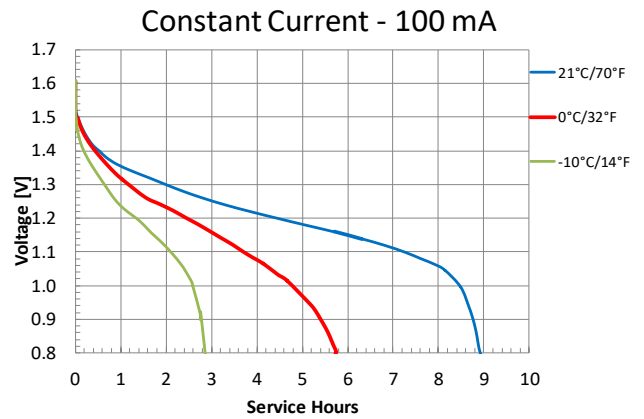
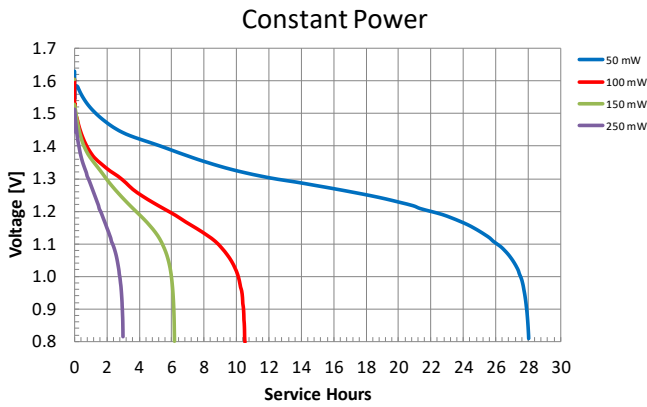
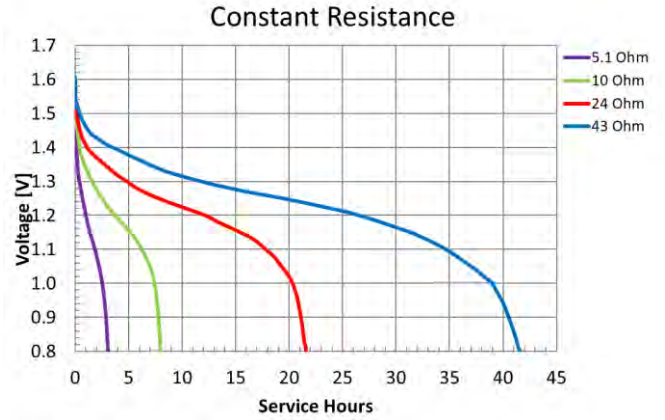
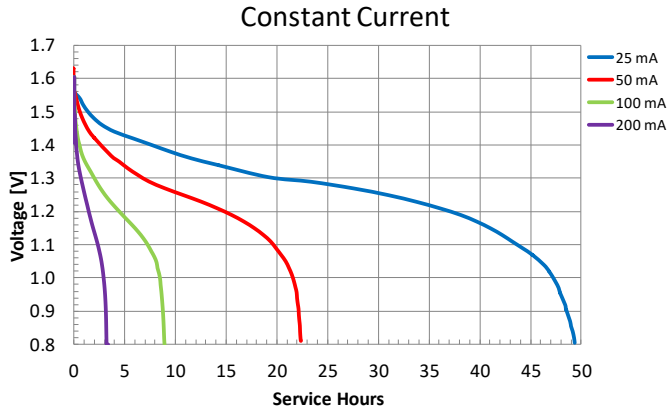

**PROCELL**<sup>®</sup>  
PROFESSIONAL BATTERIES  
Procell Professional batteries  
Berkshire Corporate Park  
Phone: 1-800-544-5454 (Toll-free)  
[www.procell.com](http://www.procell.com)

Delivered capacity is dependent on the applied load, operating temperature and cut-off voltage. Please refer to the charts and discharge data shown for examples of the energy/service life that the battery will provide for various load conditions.

This data is subject to change. Performance information is typical. Contact Duracell for the latest information.